

REVISION HISTORY			
Rev	DESCRIPTION	DATE	APPROVED
△1	Changed Detail Q ;	Apr 19 2017	Z.zhang

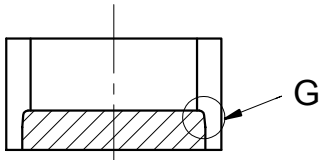

Section E-E

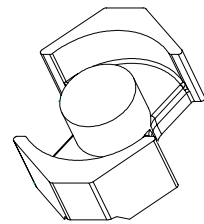
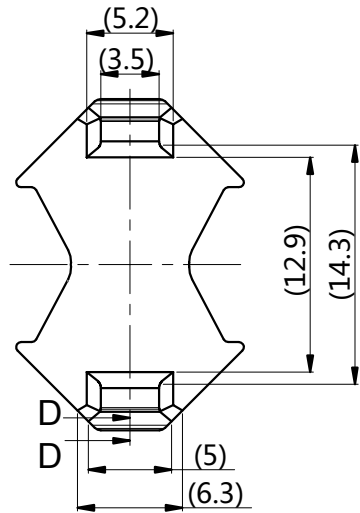
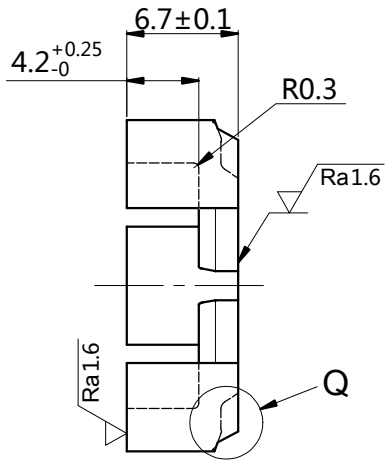
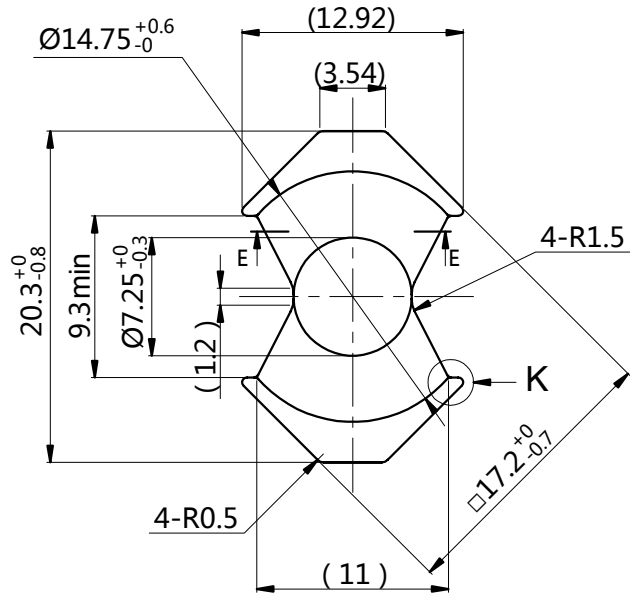
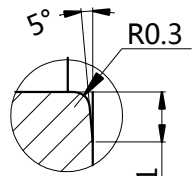

Detail G

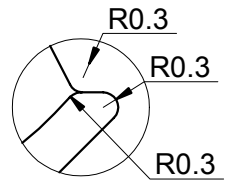

Detail K

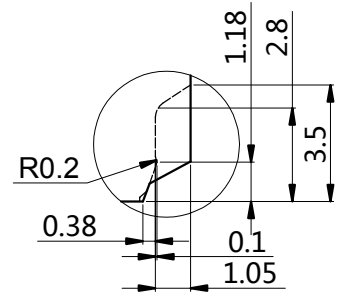

△1 Detail Q

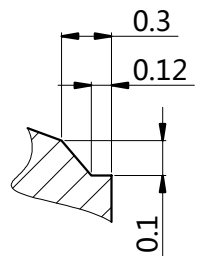

Section D-D

	Scale	2.5 : 1	Material	Customer Part number	
	Unit:	Standard tolerances		Product Name	
mm	±0.1	RM-7S		Rev	Drawing No.
Approved by	Created by	Document type	Rev	Drawing No.	
Y.Higuchi	Z.zhang	Production drawing	01	PY161117M01	
Hitachi Metals (Hong kong) Ltd. Panyu Factory			Date of issue	Sheet	
			Apr 19 2017	1/1	